

High-Definition Multimedia Interface (HDMI) Cable Assembly Compliance Test – Test Solution Overview

Component Test Division - Kobe

October 2014

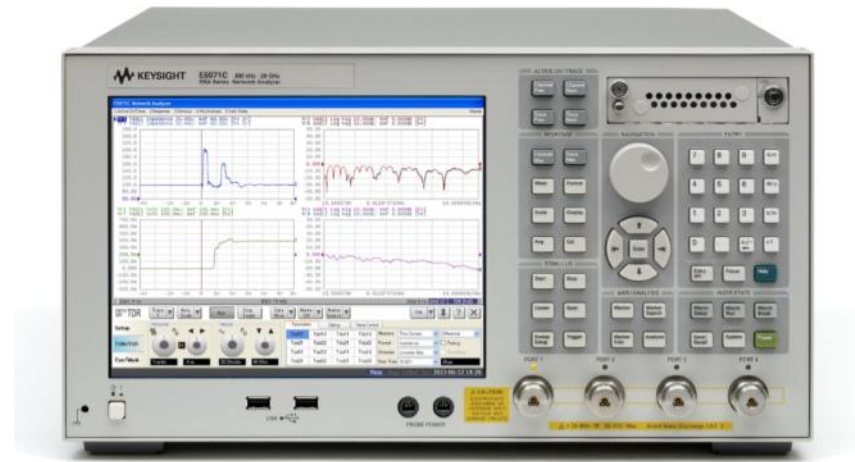

Purpose

- This slide will show how to make measurements of **High-Definition Multimedia Interface (HDMI) Cable Assembly (incl. HEAC Cable) Compliance Tests** by using the Keysight E5071C ENA Option TDR.

Keysight Digital Standards Program

Our solutions are driven and supported by Keysight experts involved in international standards committees:

- Joint Electronic Devices Engineering Council (JEDEC)
- PCI Special Interest Group (PCI-SIG®)
- Video Electronics Standards Association (VESA)
- Serial ATA International Organization (SATA-IO)
- **High-Definition Multimedia Interface (HDMI)**
- USB-Implementers Forum (USB-IF)
- Mobile Industry Processor Interface (MIPI) Alliance
- Optical Internetworking Forum (OIF)
- Mobile High-Definition Link (MHL) Consortium

We're active in standards meetings, workshops, plugfests, and seminars

Our customers test with highest confidence and achieve compliance faster



HDMI Ver.1.4 – Keysight Total Solution

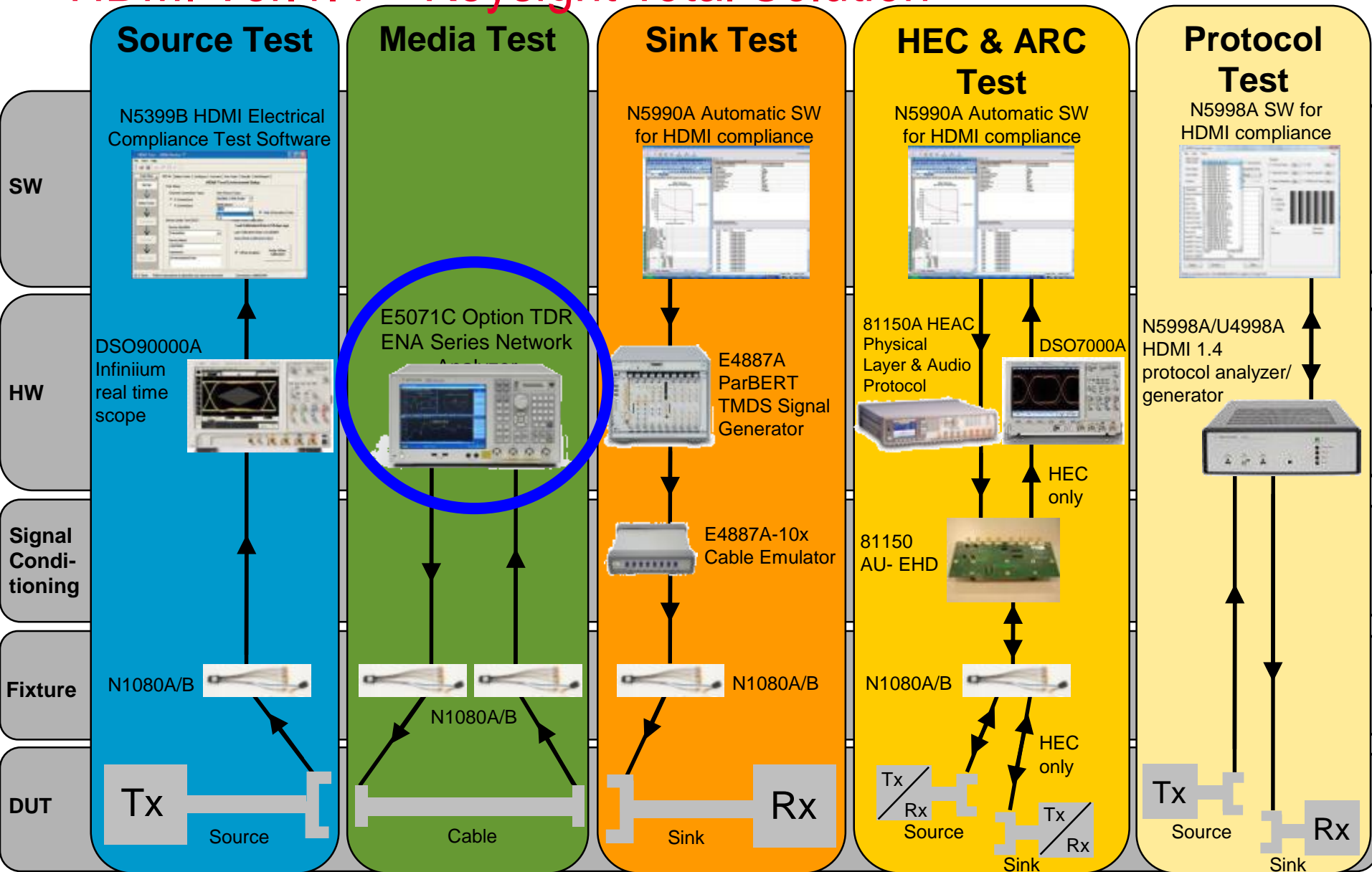

Reference Document

- High-Definition Multimedia Interface (HDMI) Specification Version 1.4b
- High-Definition Multimedia Interface (HDMI) Compliance Test Specification Version 1.4b

HDMI Cable Compliance Test

Test Setup Example

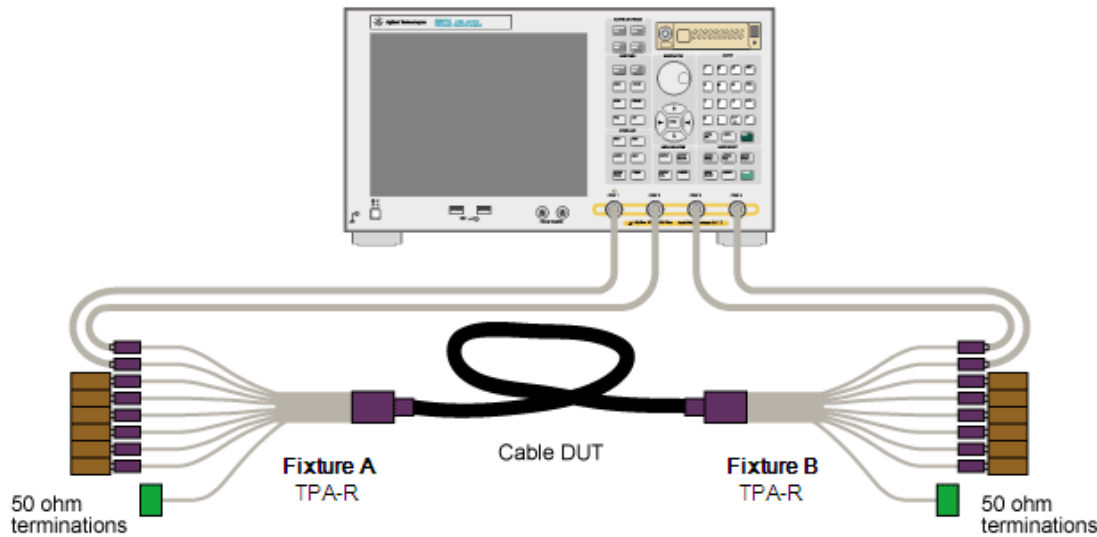

Max data rate: 3.4 Gbps / Ch

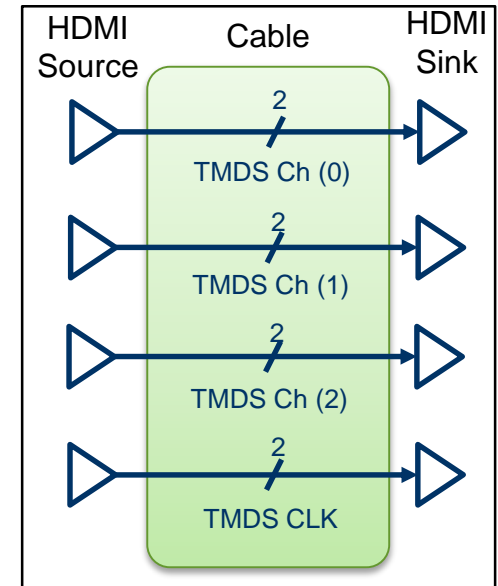

- HDMI cable and connectors carry four differential pairs that make up the TMDS data and clock channels. These channels are used to carry video, audio and auxiliary data.
- Cables are specified in two categories according to the supported clock frequency (Category 1 up to 74.25 MHz or Category 2 up to 340 MHz).

HDMI Cable Compliance Test

Measurement Parameters

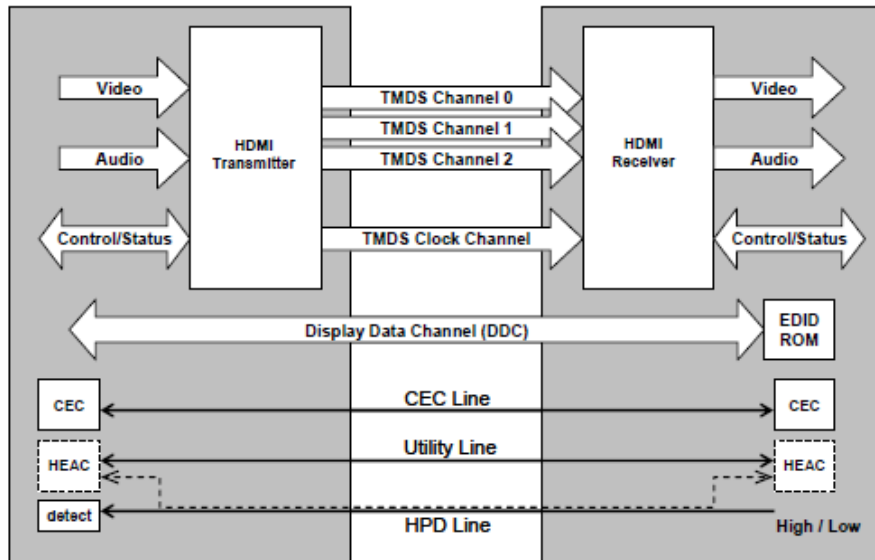

Figure 3-1 HDMI Block Diagram

Eye Diagram Measurement

Test ID 5-3: TMDS Data Eye Diagram

Time Domain Measurements

Test ID 5-4: Intra-Pair Skew

Test ID 5-5: Inter-Pair Skew

Test ID 5-8: Differential Impedance

Frequency Domain Measurements (*)

Test ID 5-6: Far End Crosstalk

Test ID 5-7: Attenuation and Phase

(*) The E5071C is certified for the frequency domain tests in HDMI Compliance Test Specification (CTS) Version 1.4b.

HDMI Cable Compliance Test

Solution Overview

- HDMI cable compliance testing requires eye diagram measurement or parametric measurements in both time and frequency domains.

Traditional Solution

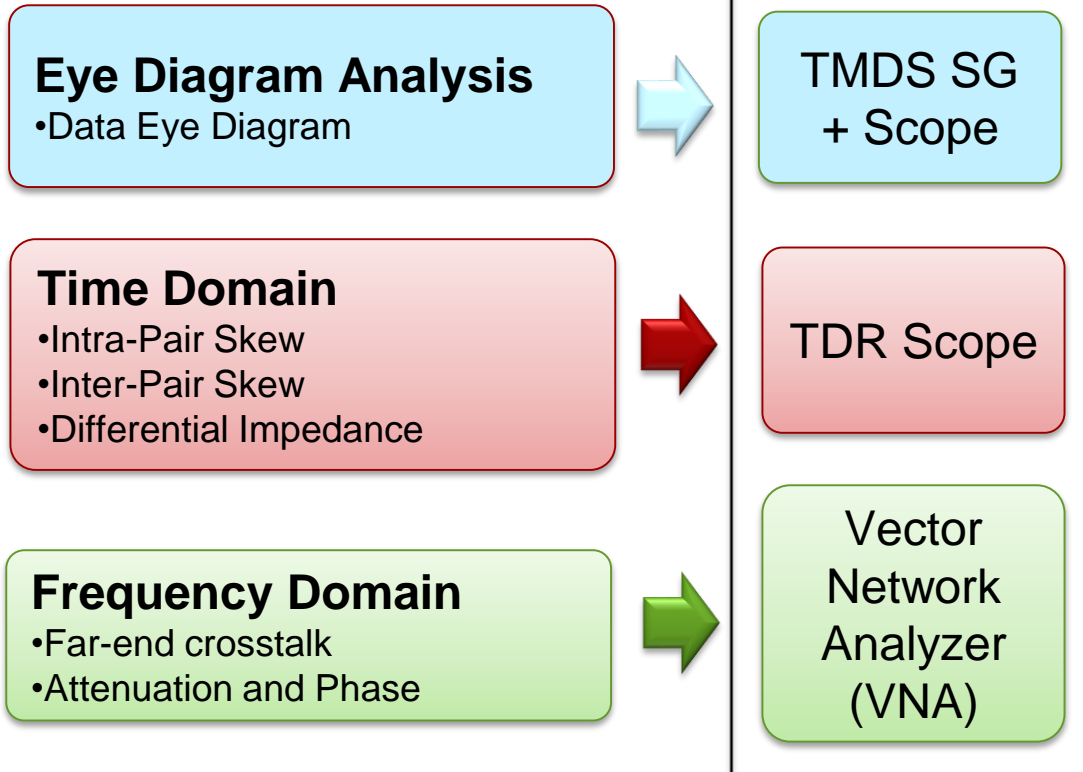

New Solution

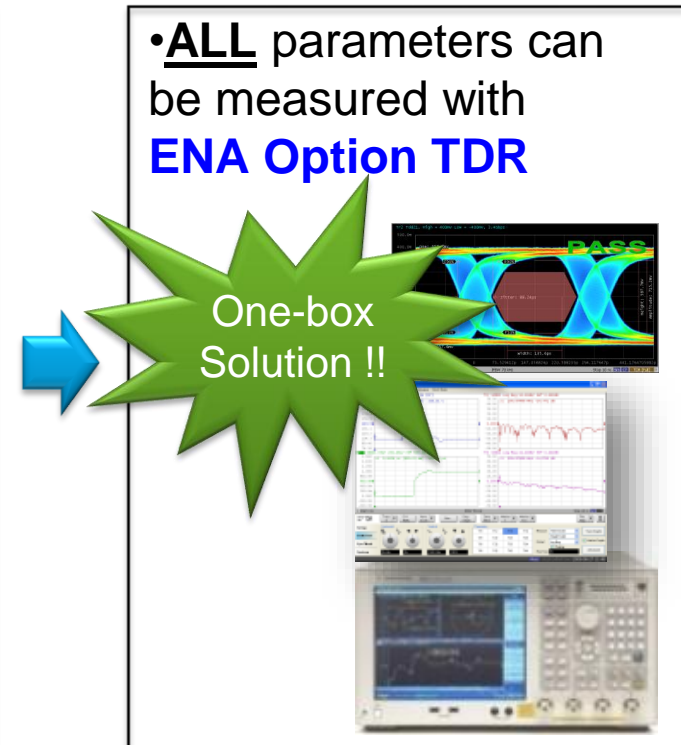

HDMI Cable Compliance Test Configuration

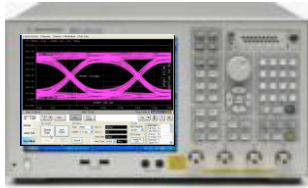

- ENA Mainframe (*1)
- E5071C-480/485: 4-port, 9 k/100 k to 8.5 GHz
- E5071C-4D5: 4-port, 300 k to 14 GHz
- E5071C-4K5: 4-port, 300 k to 20 GHz
- Enhanced Time Domain Analysis Option (E5071C-TDR)
- ECal Module
 - N4431B for E5071C-480/485
 - N4433A for E5071C-4D5/4K5

*1: Select one of frequency options.

*2: The list above includes the major equipment required. Please contact our sales representative for configuration details.

- Method of Implementation (MOI) document available for download on Keysight website.
- State files (48x,4D5,4K5) for the ENA Option TDR are also available.

www.keysight.com/find/ena-tdr_compliance
www.keysight.com/find/ena-tdr_hdmi-cabcon

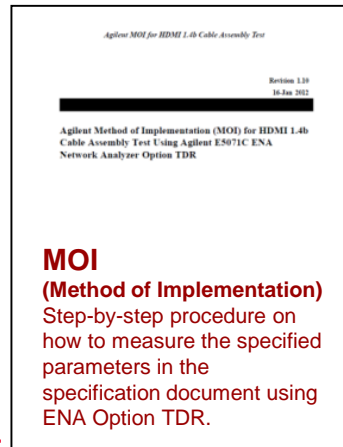

HDMI Test Fixtures

Keysight

- N1080B-H05 (receptacle)
- N1080B-H04 (plug)

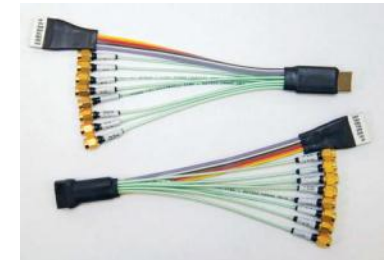

BitifEye (Type D)

- BIT-HDMI-TDRE-0001 (receptacle)
- BIT-HDMI-TDPL-0001 (plug)



HDMI Cable Compliance Test

Measurement Parameters

ENA Option TDR Compliance Testing Solution is one-box solution which provides complete characterization of interconnects (Eye diagram, time domain, frequency domain.)

Eye Diagram Analysis

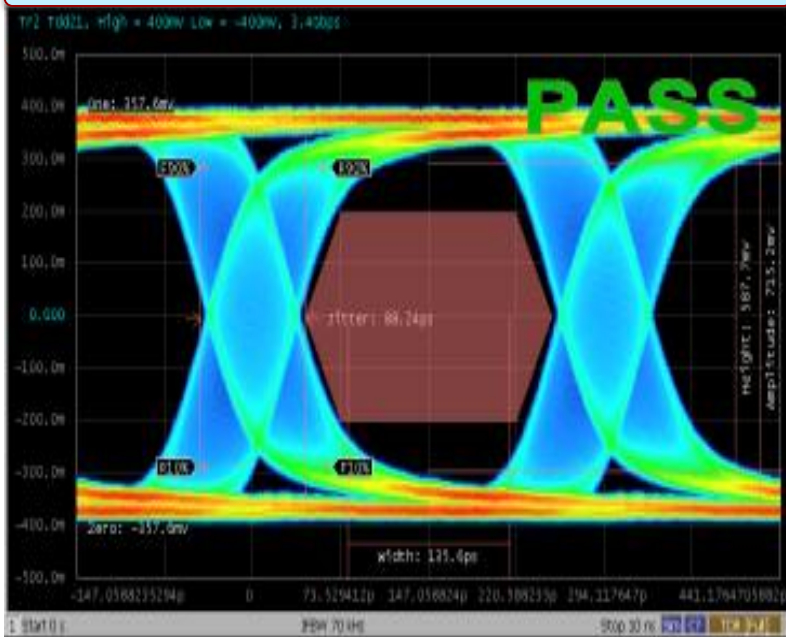

Time Domain

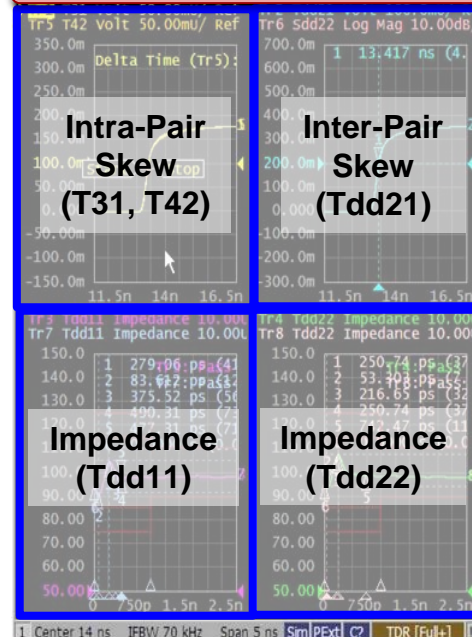

Frequency Domain

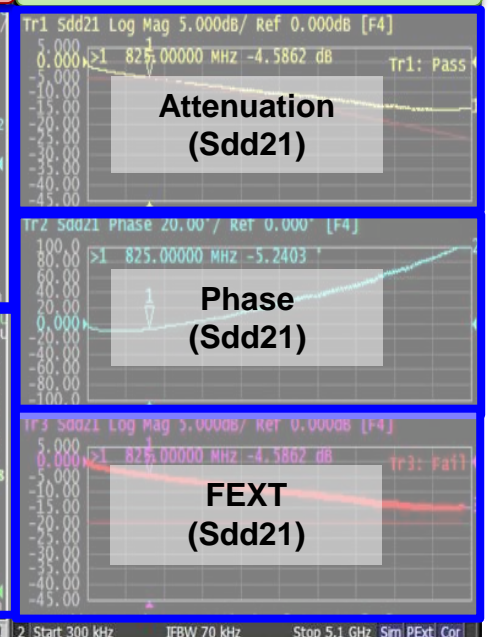

HDMI Cable Compliance Test

TMDS Data Eye Diagram

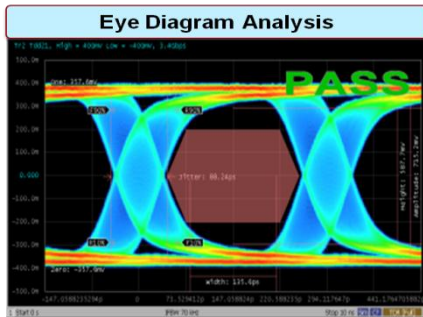

- Confirm that the Cable Assembly outputs a compliant data eye.
- The expected worst-case performance of a transmitter is applied to the Cable Assembly input and the output is evaluated with an eye diagram. (**“Stressed” eye diagram analysis**)

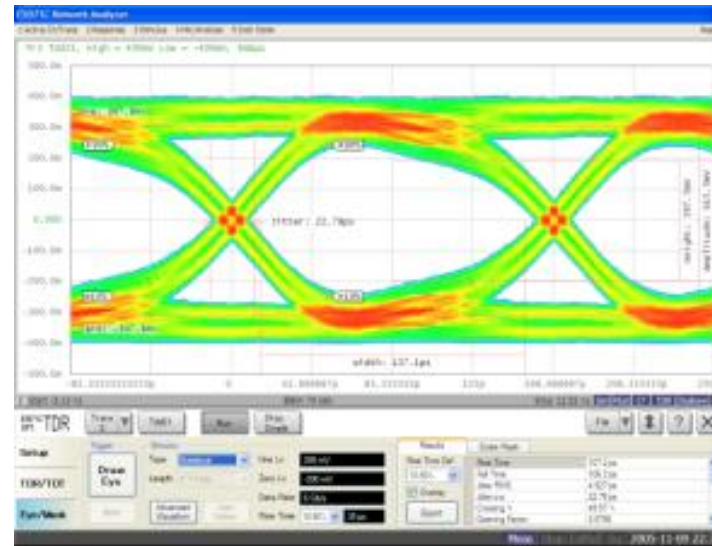
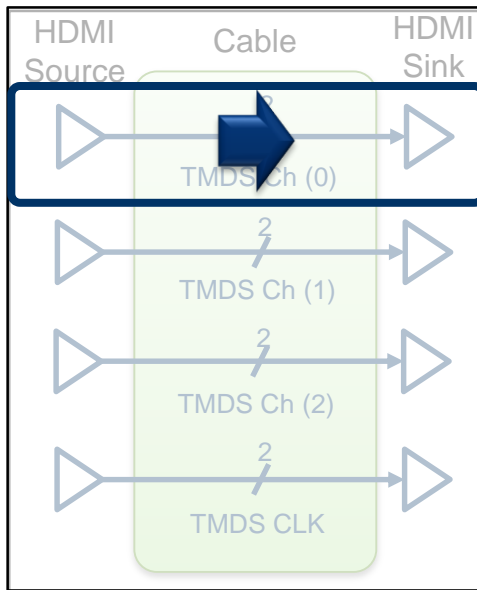

Stressed Eye Diagram Analysis

Why Measure?

Interconnects can be characterized by measuring parametric characteristics such as insertion loss and impedance.

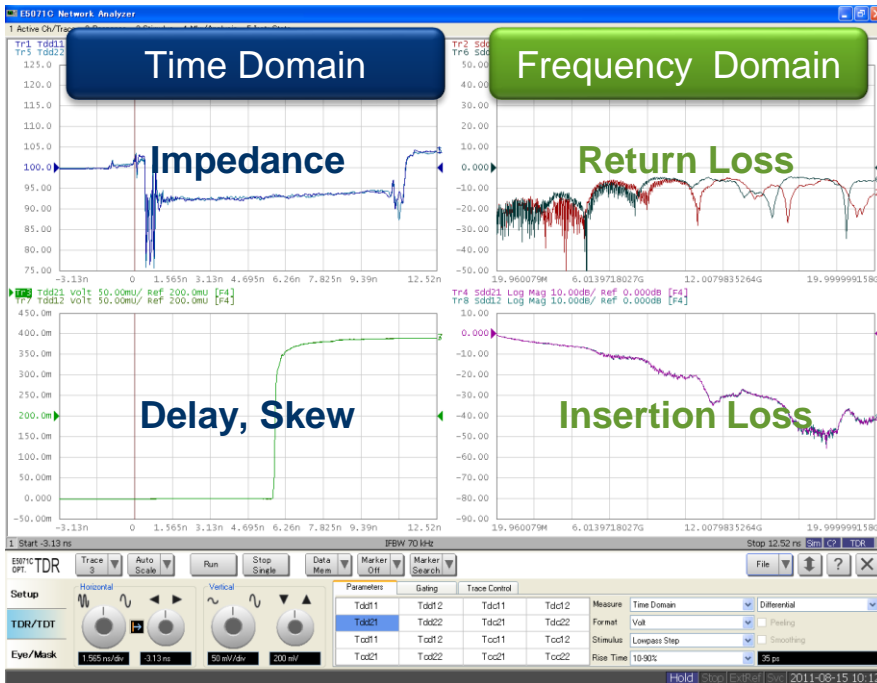

One challenge with such characterization is how to translate the measurements into what the eye diagram will look like at the end of a link....

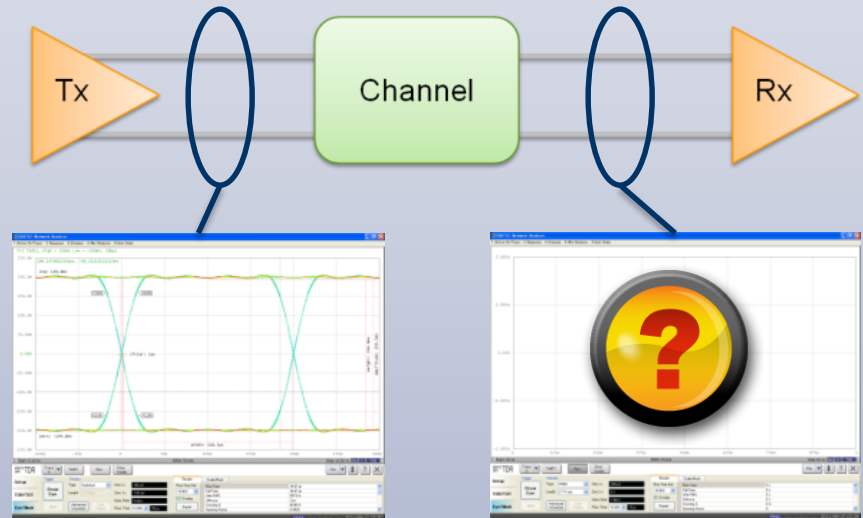

Stressed Eye Diagram Analysis

Why Measure?

Another approach is to characterize the interconnect using the eye diagram. This has the advantage of allowing direct measurement of eye characteristics at the end of the link. This process is called **“stressed” eye diagram testing**.

Input the expected worst case performance of the transmitter as the “stressed” signal to the interconnect...

... and evaluate the eye diagram at the output of the interconnect.

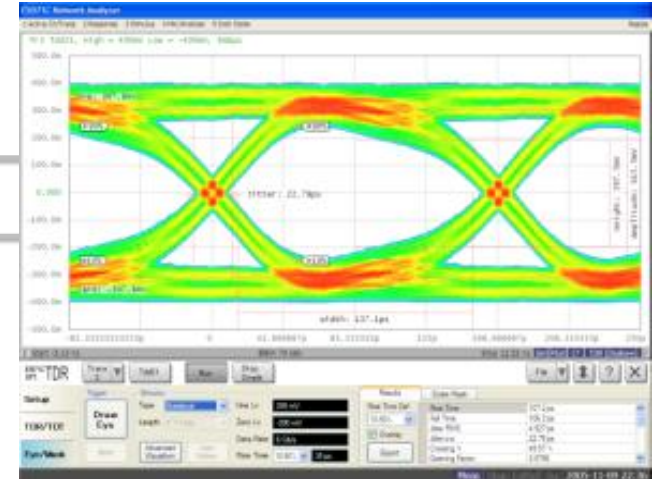
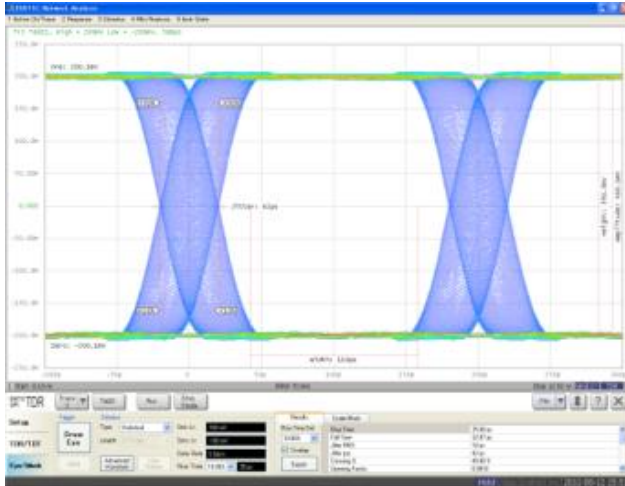

Stressed Eye Diagram Analysis

HDMI 1.4b

For HDMI Cable Assembly compliance test, there is the option of testing with either **parametric parameters**, or **stressed eye diagram**.

Stressed Eye Diagram Measurement Overview

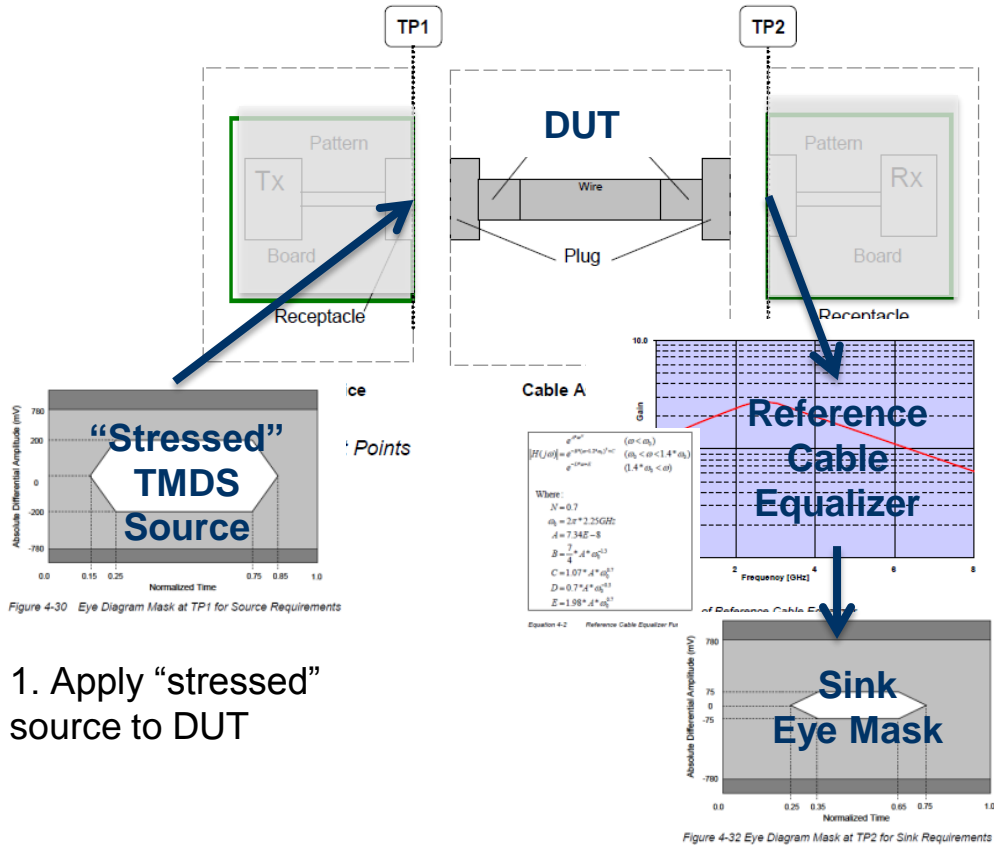

1. Apply “stressed” source to DUT

2. Apply equalizer to DUT output.

3. Set eye mask and perform mask test

Stressed Eye Diagram Analysis

Measurement Challenges



How to setup for proper measurements?

Traditional Solution

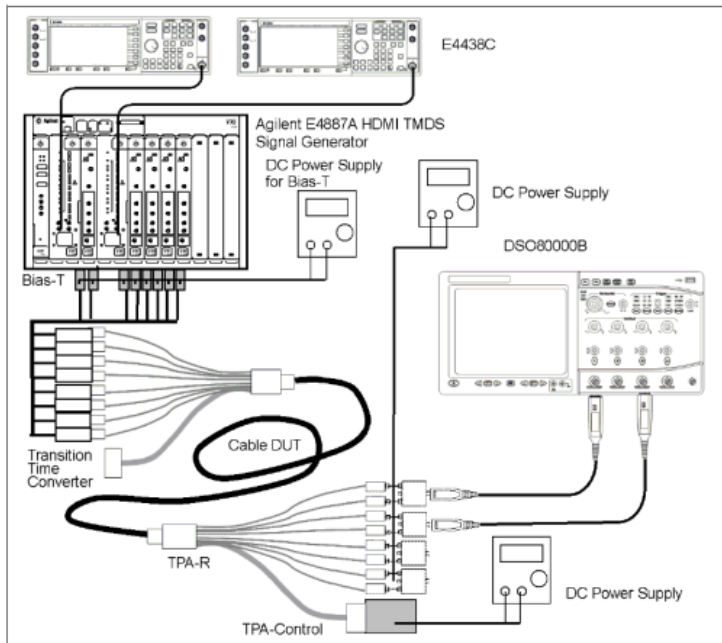

Consists of many instruments and setup and operation is **complicated**.

ENA Option TDR

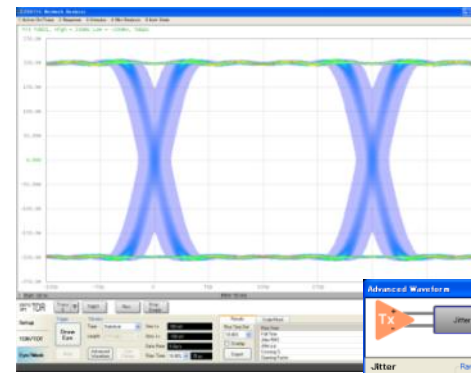

- *Jitter insertion*
- *Emphasis*
- *Equalization*

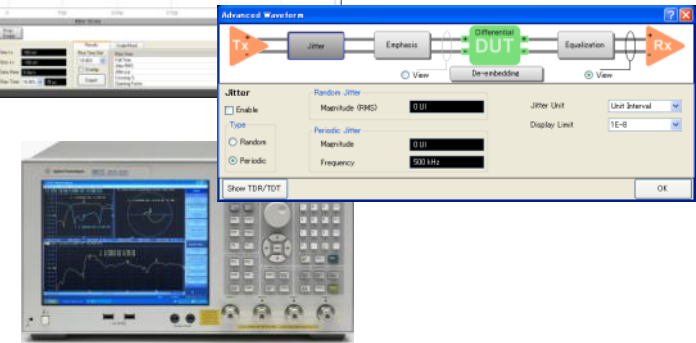

One-box solution providing **simple** setup and operation.

Stressed Eye Diagram Analysis

Measurement Challenges

⚠ How to troubleshoot and isolate root cause upon device failure?

Traditional Solution

Only **stressed eye diagram** analysis available.

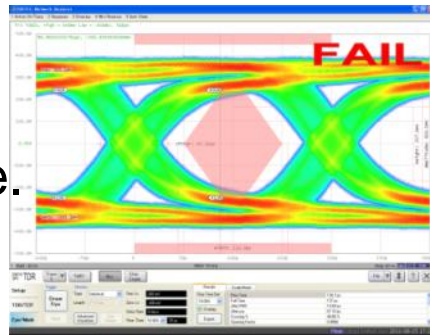

Difficult to troubleshoot and isolate root cause upon device failure just by looking at eye diagram.

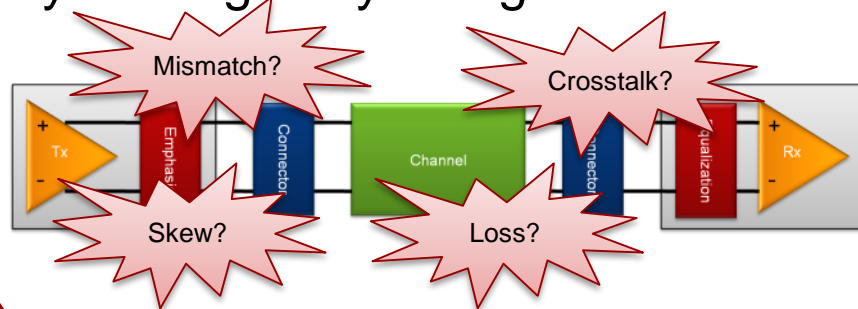

ENA Option TDR

Both **stressed eye diagram** and **parametric** analysis available.

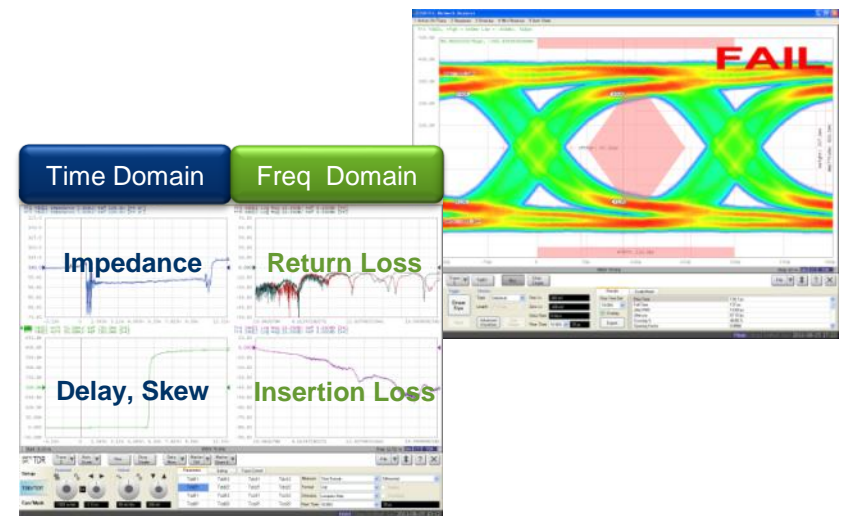

Parametric tests provide insight into root cause of device failure.

Stressed Eye Diagram Analysis Correlation

DUT: 5 m HDMI cable
 Data Bit Rate: 3.4 Gbps
 TP1: Output of a transmitter, TP2: input of a receiver (Reference Cable Equalizer)

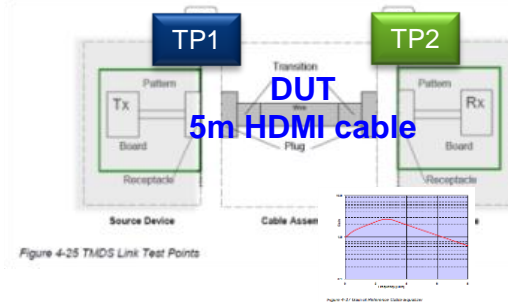

Traditional Solution

(E4887 TMD5 SG & 90000 Series Scope)

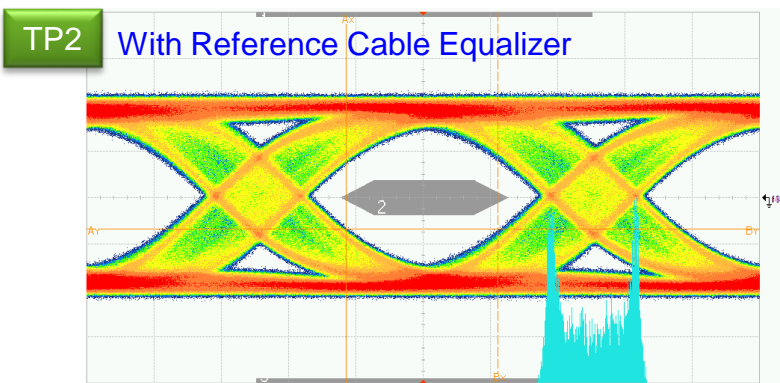
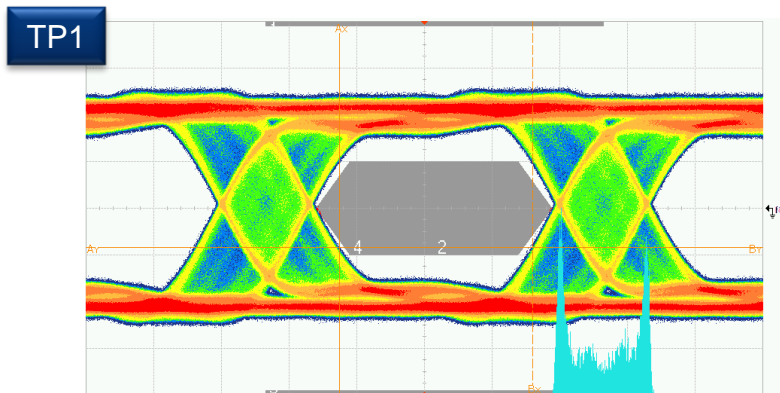

ENA Option TDR

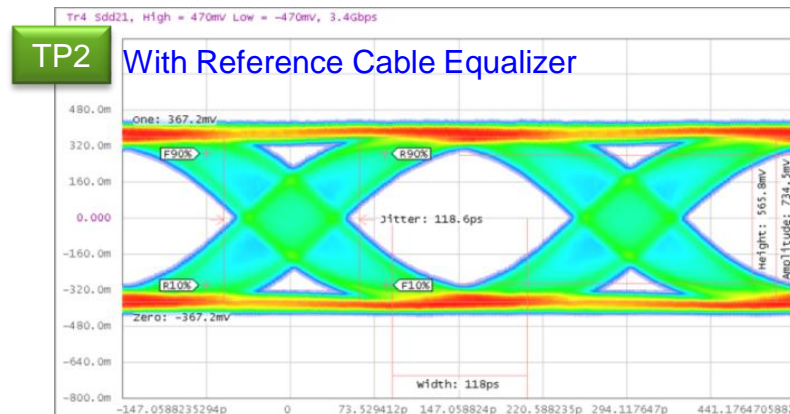
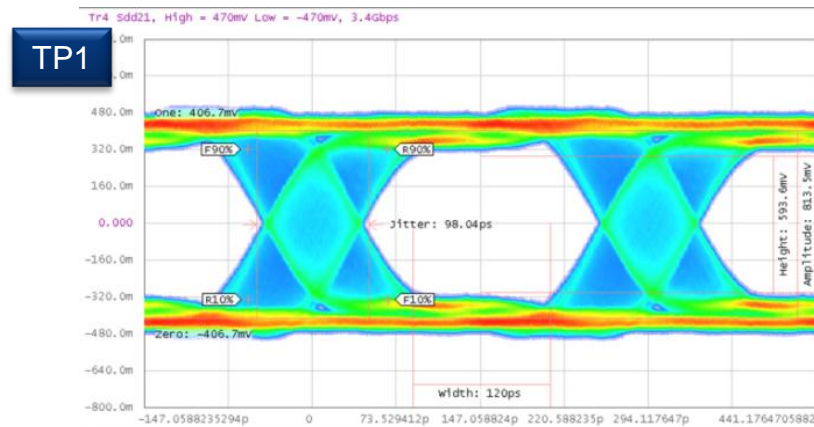

HDMI Cable Compliance Test

Parametric Test

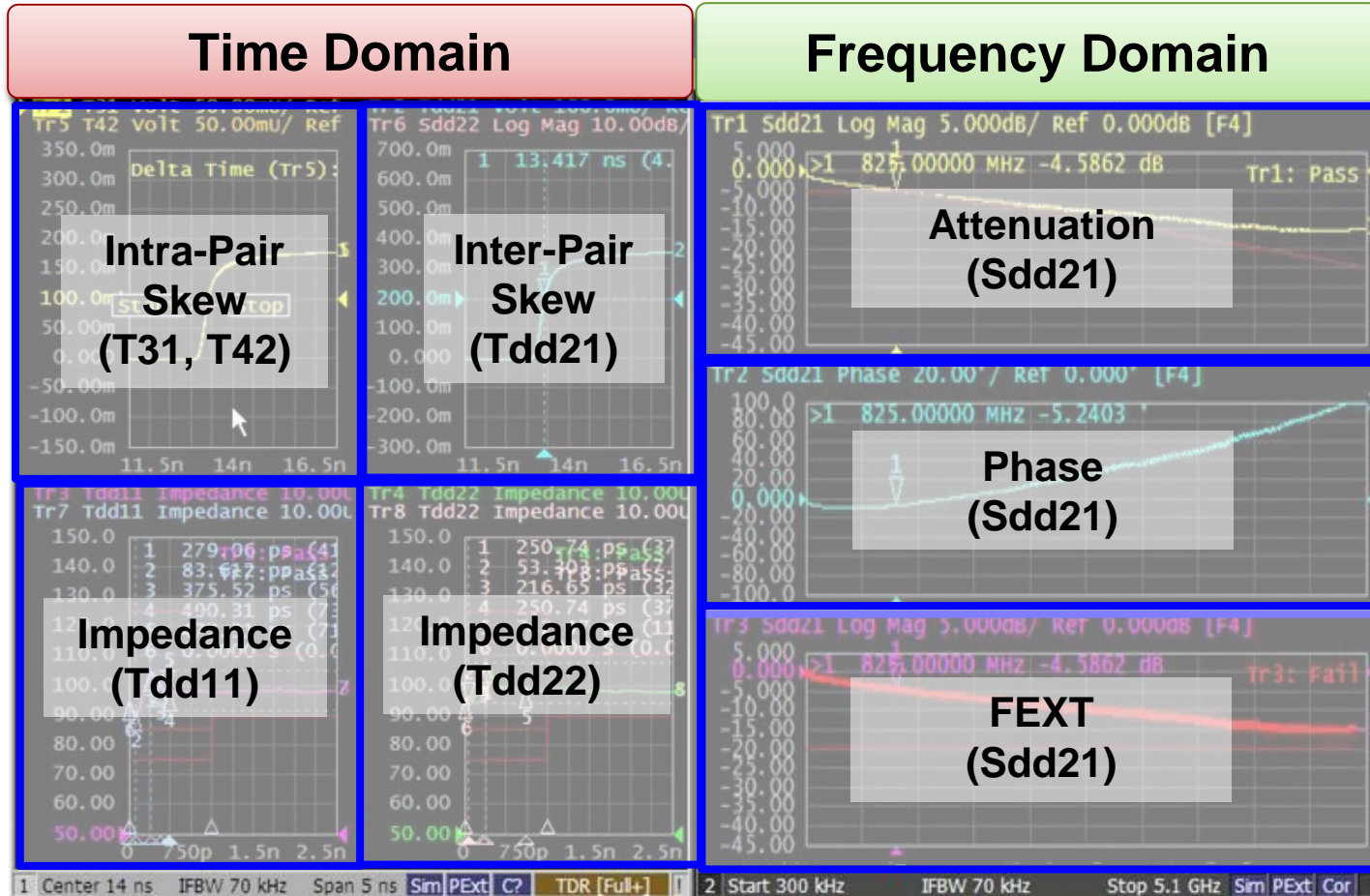

HDMI Cable Compliance Test

Intra-Pair Skew

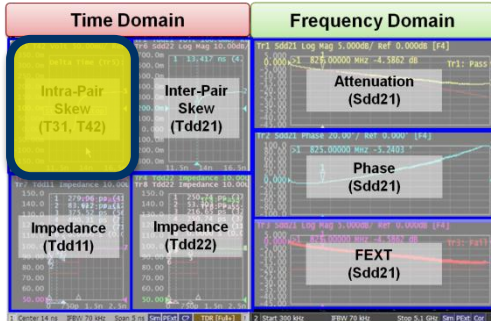

- Confirm that the Cable Assembly does not have intra-pair skew on the TMDS lines greater than that allowed in the specification.
- Excessive Intra-pair skew can distort the rising edge of the signal, lead to significant differential to common mode conversion.

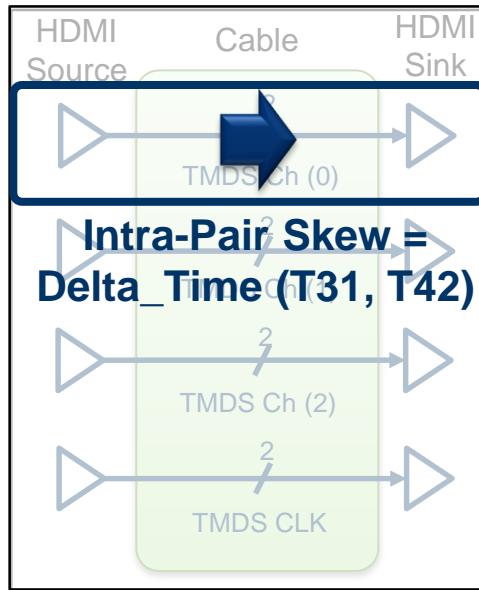

Intra-Pair Skew Limit

CDF field Cable_Category	CDF field Cable_Configuration	Limit Max	Unit
1	Home	151	ps
	Automotive_EE	336	ps
	Automotive_AA	101	ps
	Automotive_EA	235	ps
2	All	112	ps

HDMI Cable Compliance Test

Inter-Pair Skew

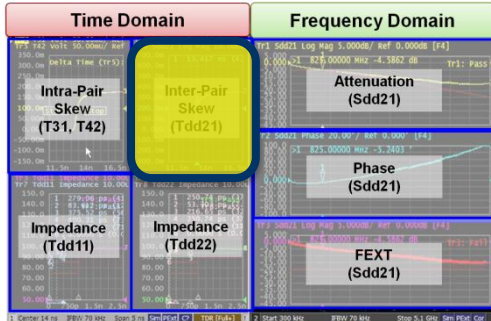

- Confirm that the Cable Assembly does not have inter-pair skew on the TMDS lines greater than that allowed in the specification.
- Inter-Pair skew results from electrical length difference between channels.

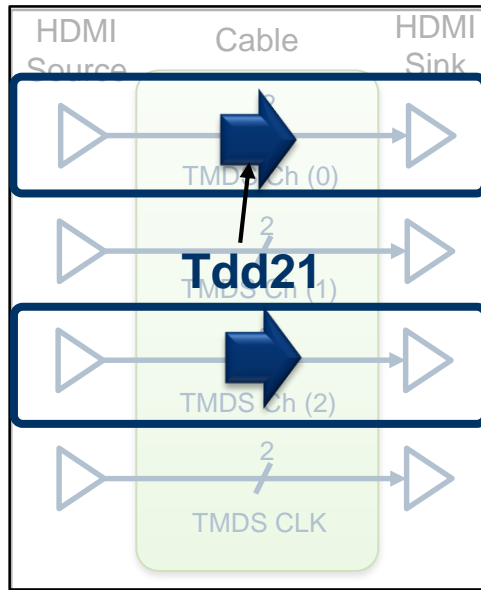

Inter-Pair Skew Limit

CDF field Cable_Category	CDF field Cable_Configuration	Limit Max	Unit
1	Home	2.42	ns
	Automotive_EE	5.38	ns
	Automotive_AA	1.61	ns
	Automotive_EA	3.77	ns
2	All	1.78	ns

HDMI Cable Compliance Test

Differential Impedance

- Confirm that the Cable Assembly does not have differential impedance on the TMDS lines outside the tolerances allowed in the specification.
- Multiple reflections from impedance mismatches cause noise at the receiver.

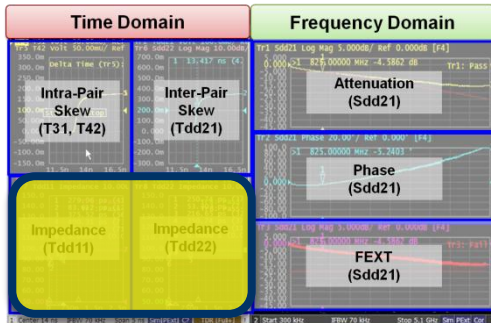

Impedance Limit @ rise time of 200 ps

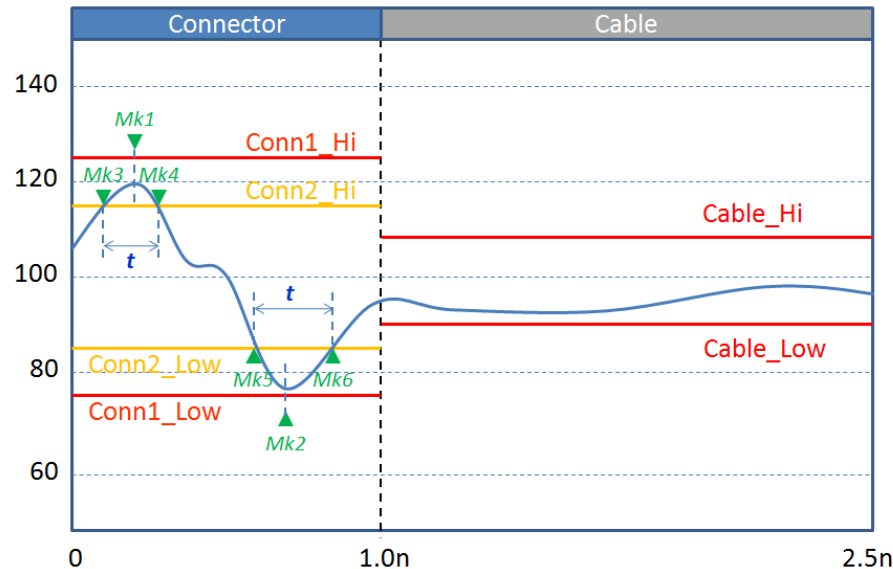
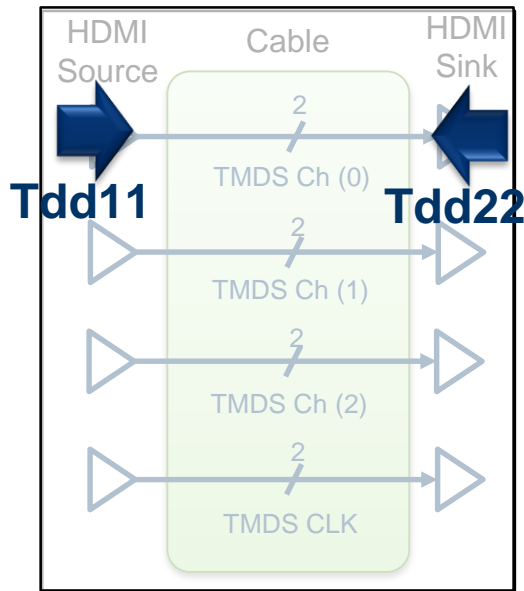

*1. A single excursion at connector area is permitted out to a maximum of 100 ohm +/-25 % ("Conn1_Hi/Low") and of a duration less than 250 psec.

HDMI Cable Compliance Test

Attenuation

- Confirm that the Cable Assembly does not have attenuation on the TMDS lines greater than that allowed in the specification.
- Attenuation is the loss through the differential pairs.
- Has important consequences for the rise time degradation and the maximum supportable bandwidth.

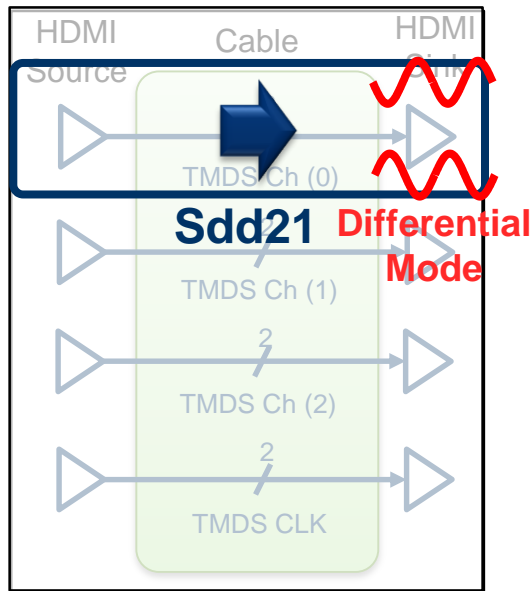
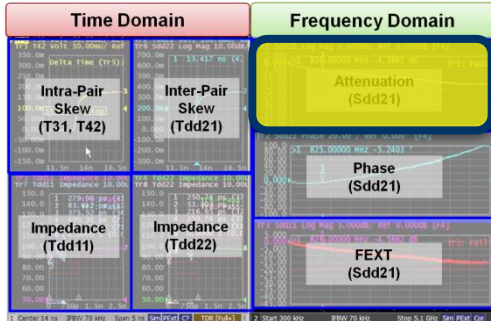

Attenuation Limit (for Category 2 Non Equalized Cable)

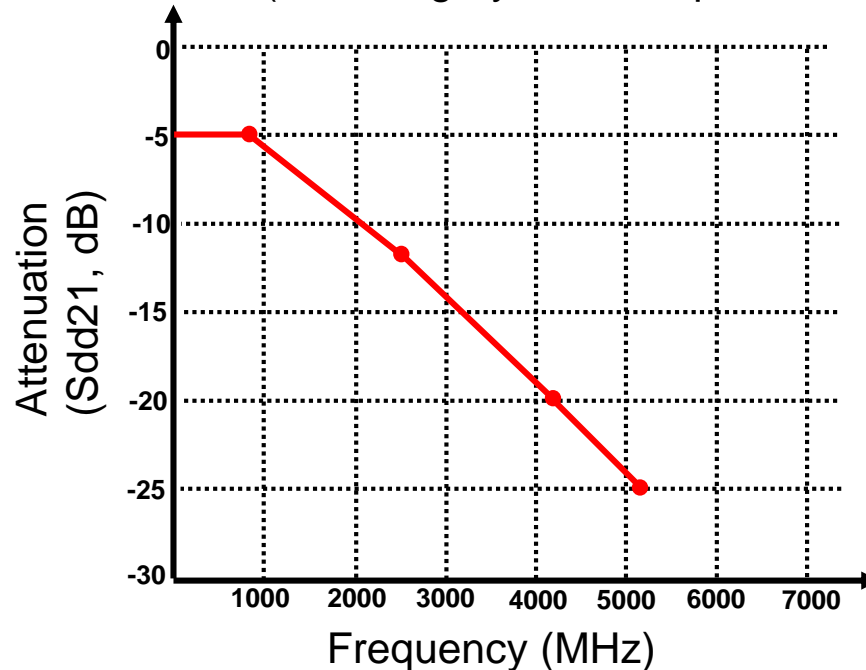

HDMI Cable Compliance Test

Phase

- Confirm that the Cable Assembly does not have phase on the TMDS lines greater than that allowed in the specification.

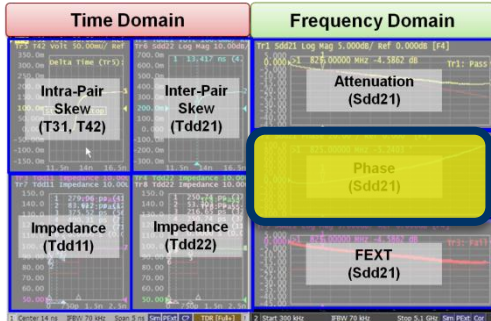

Phase Limit (for Passive Equalized Cable)

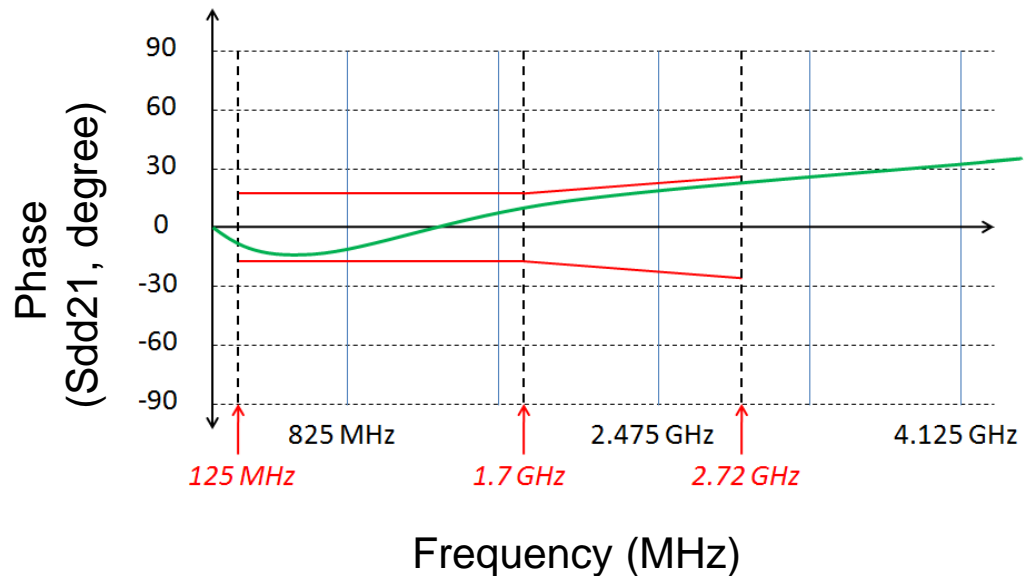
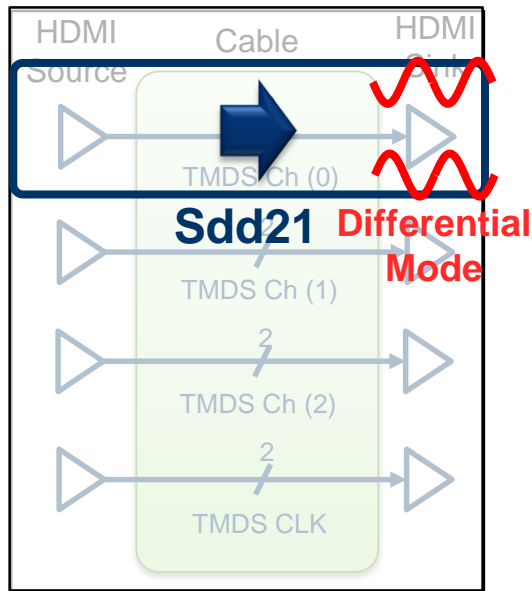

HDMI Cable Compliance Test

Far end Crosstalk

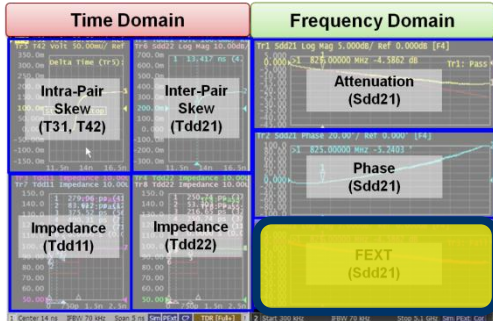

- Confirm that the Cable Assembly does not have crosstalk at the far-end between the TMDS lines greater than that allowed in the specification.
- Measurements are repeated for all combinations of TMDS pairs (CLK, Ch(0 to 2))

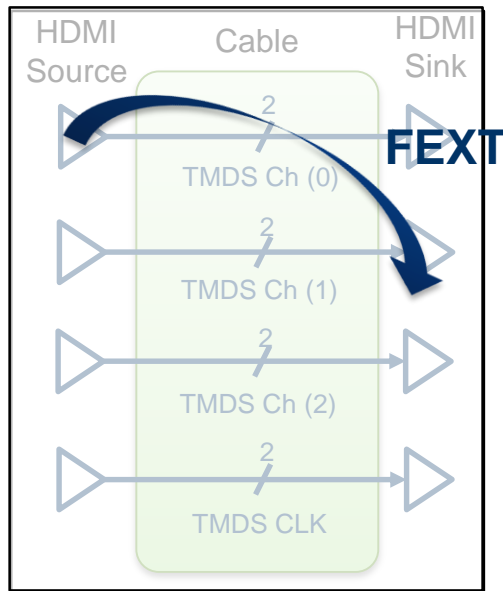

- If crosstalk ≥ -20 dB (300 k to 5 GHz) then FAIL.

HDMI Ethernet and Audio Return Channel (HEAC) Cable Compliance Test

Measurement Parameters

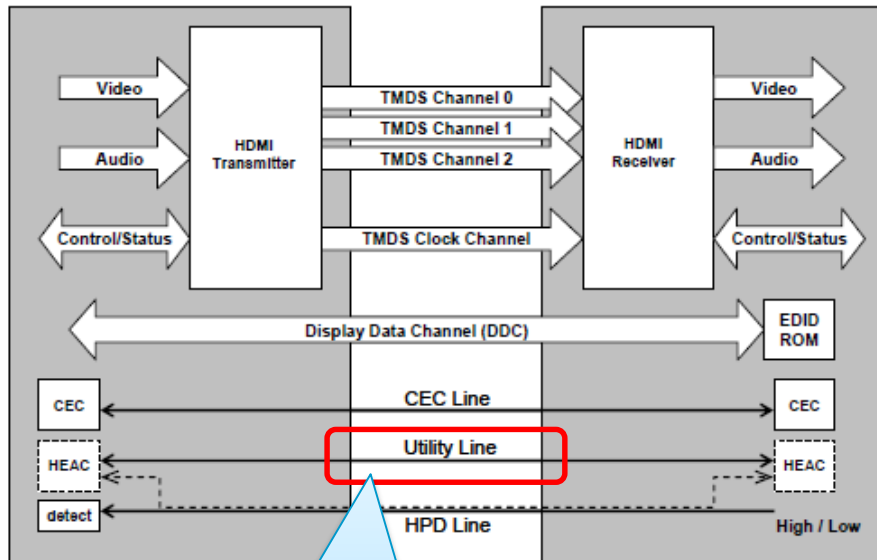
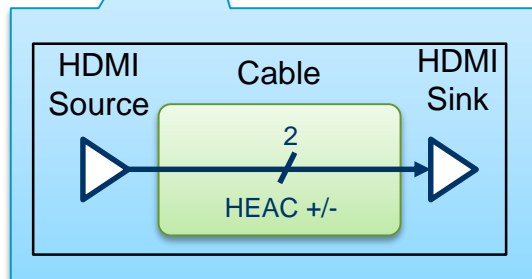

Figure 3-1 HDMI Block Diagram



Time Domain Measurements

Test ID HEAC 6-1: Intra-Pair Skew

Test ID HEAC 6-3: Differential/Common Mode Impedance

Frequency Domain Measurements (*)

Test ID HEAC 6-2: Differential Attenuation

(*) The E5071C is certified for the frequency domain tests in HDMI Compliance Test Specification (CTS) Version 1.4b.

HEAC Cable Compliance Test

Intra-Pair Skew

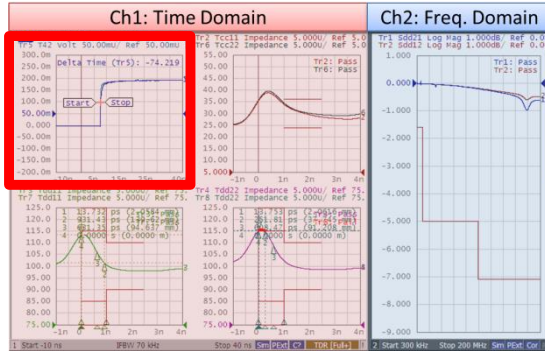

- Confirm that the intra-pair skew in the HDMI cable with HEAC is within the specified limit.
- Maximum Cable Assembly Intra-pair skew: 111 ps

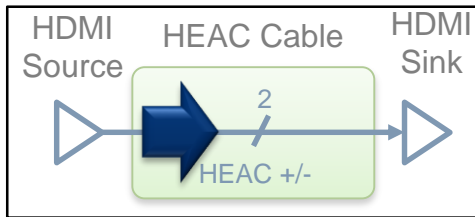

**Intra-Pair Skew =
Delta_Time (T31, T42)**

HEAC Cable Compliance Test

Differential/Common Mode Impedance

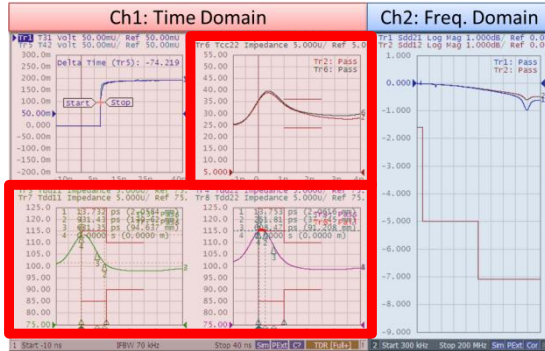

- Confirm the differential and common mode impedance of the HDMI cable with HEAC is within the specified limits.

Differential Impedance

- Connection point and transition area (Up to 1 ns): $100\Omega \pm 15\%^*$
- Cable area (1 ns – 2.5 ns): $100\Omega \pm 10\%$

* A single excursion is permitted out to a max/min of $100\Omega \pm 25\%$ and of a duration less than 250 ps.

Common Mode Impedance

- Cable area (1 ns – 2.5 ns): $30\Omega \pm 20\%$

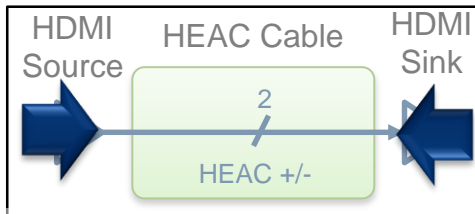

Tdd11
/Tcc11

Tdd22
/Tcc22

HEAC Cable Compliance Test

Differential Attenuation

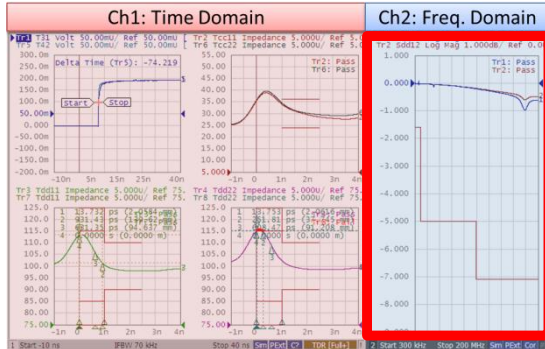

• Confirm that the lower limit of the differential attenuation of HDMI cable with HEAC is within specified limits.

- Differential Attenuation
- 300kHz – 10MHz < 1.6 dB
- 10MHz – 100MHz < 5 dB
- 100MHz – 200MHz < 7.1 dB

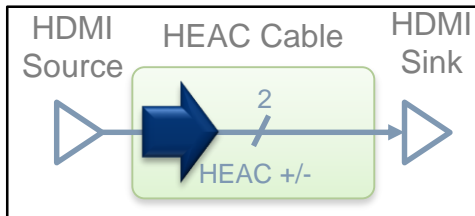

Sdd21/Sdd12

ENA Option TDR Compliance Test Solution

Certified MOIs available at www.keysight.com/find/ena-tdr_compliance

Cable/Connector/Interconnect



Time & Frequency



Frequency



Time & Frequency



Time & Frequency

100BASE-TX

Time & Frequency

10GBASE-T

Time & Frequency

10GBASE-KR/40GBASE-KR4

Time & Frequency



Time & Frequency



Time

BroadR-Reach *

Time & Frequency

Transmitter/Receiver Impedance (Hot TDR/RL)



Time



Time & Frequency



Time & Frequency



Time & Frequency

10GBASE-KR/40GBASE-KR4

Frequency



Time & Frequency *



* For more detail about Thunderbolt and BroadR-Reach compliance test solution using the ENA Option TDR, contact Keysight sales representative.

ENA Option TDR Compliance Test Solution

Certified Test Centers using ENA Option TDR

Test Centers Support ENA Option TDR

ENA Option TDR is used world wide by certified test centers of USB, HDMI, DisplayPort, MHL, Thunderbolt and SATA.

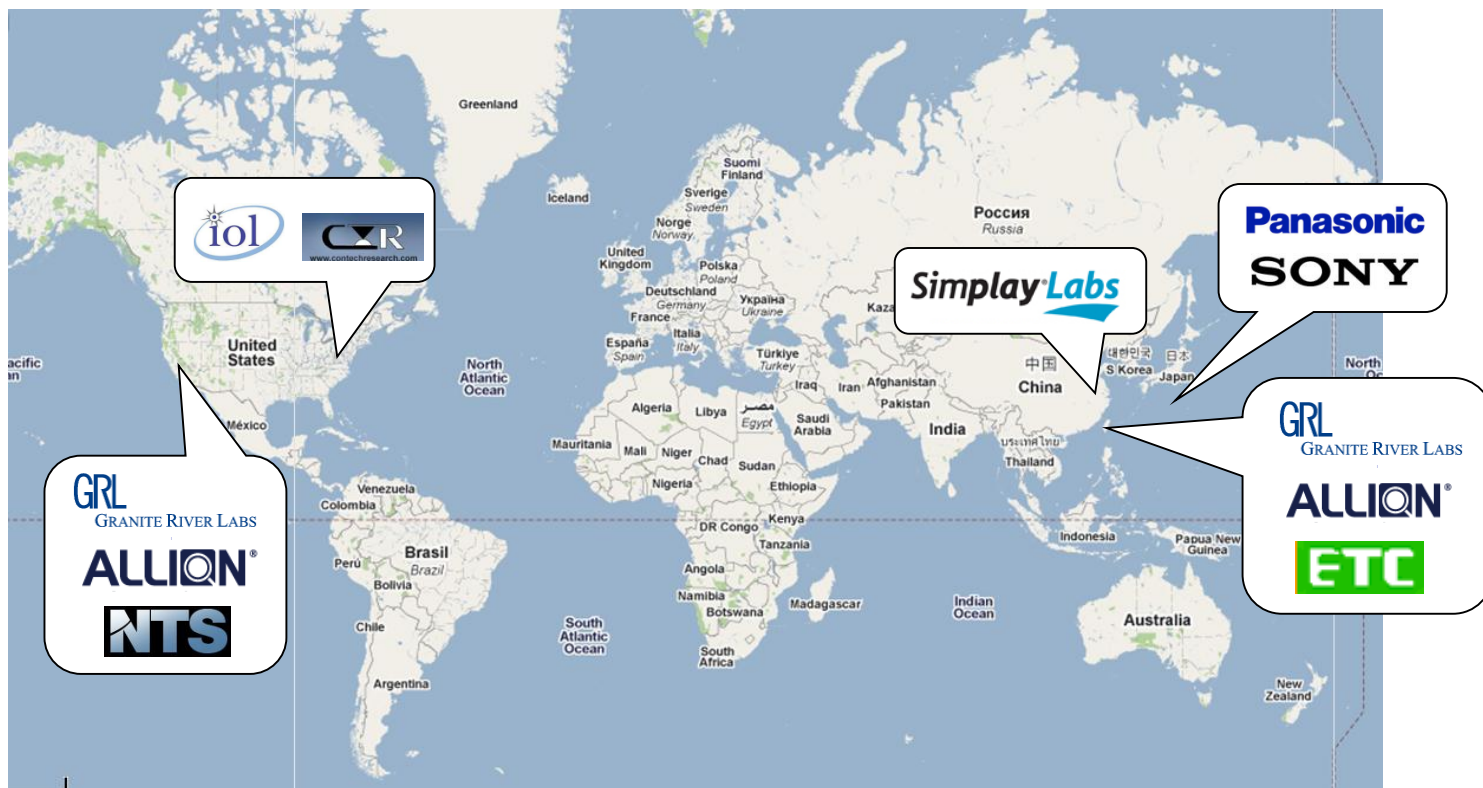

ENA Option TDR Compliance Test Solution

Summary

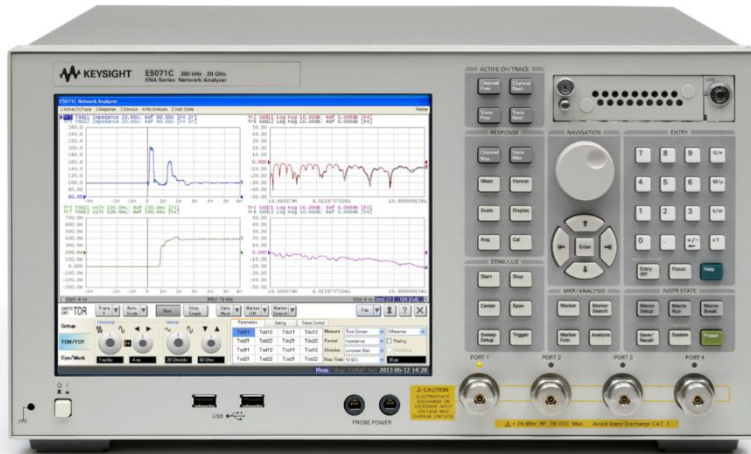

ENA Option TDR Cable/Connector Compliance Testing Solution is

- **One-box solution** which provides complete characterization of high speed digital interconnects (time domain, frequency domain, eye diagram)
- Similar look-and-feel to traditional TDR scopes, providing **simple and intuitive operation** even for users unfamiliar to VNAs and S-parameters
- Adopted by test labs worldwide



Questions?

Keysight VNA Solutions

Performance



FieldFox

Handheld RF Analyzer
5 Hz to 4/6 GHz



E5061B

NA + ZA in one-box
5 Hz to 3 GHz
Low cost RF VNA
100 k to 1.5/3.0 GHz



E5071C

World's most popular economy VNA
9 kHz to 4.5, 8.5 GHz
300 kHz to 20.0 GHz



E5072A

Best performance ENA
30 kHz to 4.5, 8.5 GHz

ENA Series



PNA

Performance VNA
10 M to 20, 40, 50, 67, 110 GHz
Banded mm-wave to 2 THz



PNA-L

World's most capable value VNA
300 kHz to 6, 13.5, 20 GHz
10 MHz to 40, 50 GHz



PNA-X receiver

8530A replacement



PNA-X, NVNA

Industry-leading performance
10 M to 13.5/26.5/43.5/50/67 GHz
Banded mm-wave to 2 THz



Mm-wave solutions

Up to 2 THz

PNA Series

What is ENA Option TDR?

The ENA Option TDR is an application software embedded on the ENA, which provides an **one-box solution** for high speed serial interconnect analysis.

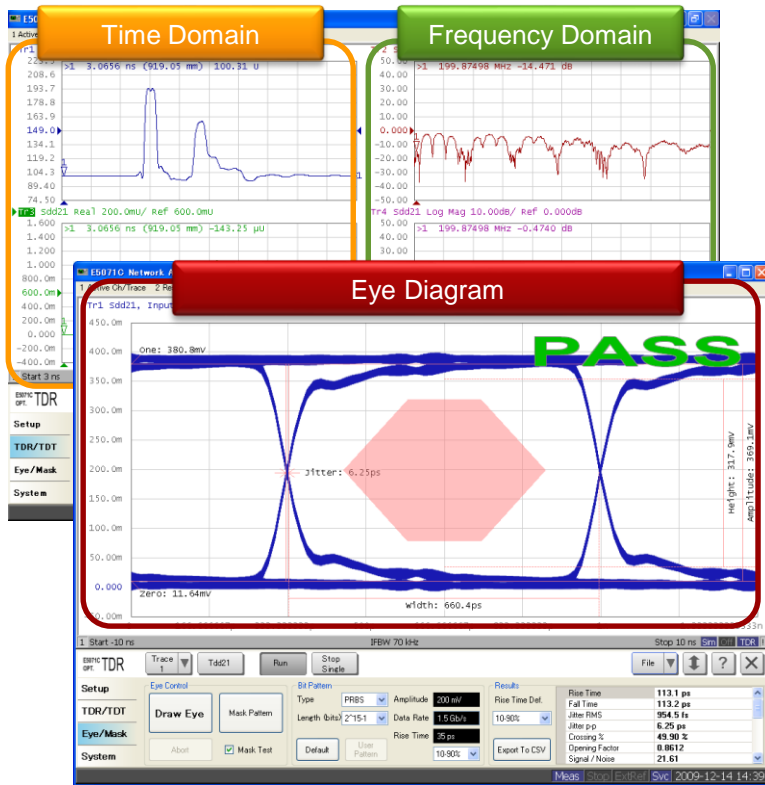

3 Breakthroughs

for Signal Integrity Design and Verification

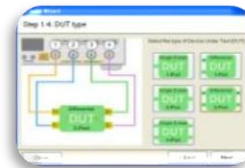

Simple and Intuitive Operation



Fast and Accurate Measurements



ESD Robustness

What is ENA Option TDR?

[Video]

Keysight ENA Option TDR

Change the world of Time Domain Reflectometry (TDR) Measurements

- youtu.be/uBHXkzk4lzk?list=PLG98L-F0jgVj-jeYUheKdpGhr5z1Jg4q_
- www.keysight.com/find/ena-tdr



Additional Resources

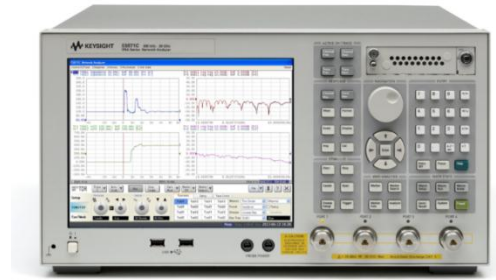

•ENA Option TDR Reference Material

www.keysight.com/find/ena-tdr

- Technical Overview (5990-5237EN)
- Application Notes
- Correlation between TDR oscilloscope and VNA generated time domain waveform (5990-5238EN)
- Comparison of Measurement Performance between Vector Network Analyzer and TDR Oscilloscope (5990-5446EN)
- Effective Hot TDR Measurements of Active Devices Using ENA Option TDR (5990-9676EN)
- Measurement Uncertainty of VNA Based TDR/TDT Measurement (5990-8406EN)
- Accuracy Verification of Agilent's ENA Option TDR Time Domain Measurement using a NIST Traceable Standard (5990-5728EN)

•Method of Implementation (MOI) for High Speed Digital Standards

www.keysight.com/find/ena-tdr_compliance